

MODEL NUMBER A2T21-A15

ITEM NO.	PART DESCRIPTION	PART NUMBER	QUAN.
1	MAIN LEG BRACKET	1551-0000	4
2	SUPPORT PIN 11/16 DIA. X 4 9/16 LG.	5017-0004	4
3	SPACER BAR 33 3/4 LG.	1744-0008	2
4	COTTER PIN 1/4 X 1 1/4 LG.	60-0070	8
5	HEX. NUT 3/8-24NC	54-0100	4
6	SOC. SET SCREW 3/8-24NF X 1 3/4 LG.	63-0110	4
7	SOC. SET SCREW 3/8-24NF X 1 LG.	63-0100	4
8	LEG BRACE BRACKET	1763-0000	4
9	SUPPORT PIN 11/16 DIA. X 4 1/8 LG.	2853-0000	4
10	MAIN LEG SWIVEL PIN	1559-0000	4
11	LEG BRACE SWIVEL PIN	1563-0000	4
12	HEX. HD. BOLT 3/4-10NC X 2 1/2 LG.	51-0480	4
13	TROLLEY STOP ANGLE	5132-0000	4
14	KEY RING 2 1/4 OD.	82-0030	10
15	CAUTION TAG No. 399	1969-RING	12
16	LOCK WASHER INT. TOOTH 3/4	58-0040	4
17	HEX. NUT 3/4-10NC	54-0040	4
18	I BEAM AL. 12" X 15' LG.	753-0150	1
19	LEG BRACE ASSEMBLY	1542-0140	4
20	MAIN LEG ASSEMBLY	1650-0141	4
21	UPPER MAIN LEG	1651-0140	4
22	ROLL PIN 5/32 X 3/4 LG.	61-0300	4
23	LOAD PIN	3016-0000	4
24	EXTENSION SPRING	1017-0000	8
25	LOWER MAIN LEG	1652-0140	4
26	CASTER FRAME ASSEMBLY	696-0010	2
27	LOWER MAIN LEG PIN ASSEMBLY	1999-0000	4
28	HEX. HD. BOLT 1/2-13NC X 4 LG.	51-0460	4
29	SAFETY CABLE ASS'Y 155" LG.	1967-0030	2
30	OUTER CASTER FRAME TUBE	697-0010	2
31	CASTER FRAME ADJUSTMENT PIN	1392-0000	2
32	INNER CASTER FRAME TUBE	698-0010	2
33	CASTER CASTING FOR INNER TUBE	2455-0010	2
34	CASTER CASTING FOR OUTER TUBE	2456-0010	2
35	LOCK WASHER INT. TOOTH 1/2	58-0020	4
36	HEX. NUT 1/2-13NC	54-0050	4
37	HEX. HD. BOLT 3/8-16NC X 1 1/2 LG.	51-0190	16
38	LOCK WASHER INT. TOOTH 3/8	58-0060	16
39	HEX. NUT 3/8-16NC	54-0060	16
40	CASTER WHEEL 8" DIA.	47-0010	4
41	SAFETY STOP ASSEMBLY	3112-0001	4



Wallace Cranes Parts Location

Round Tube Tri-Adjustable

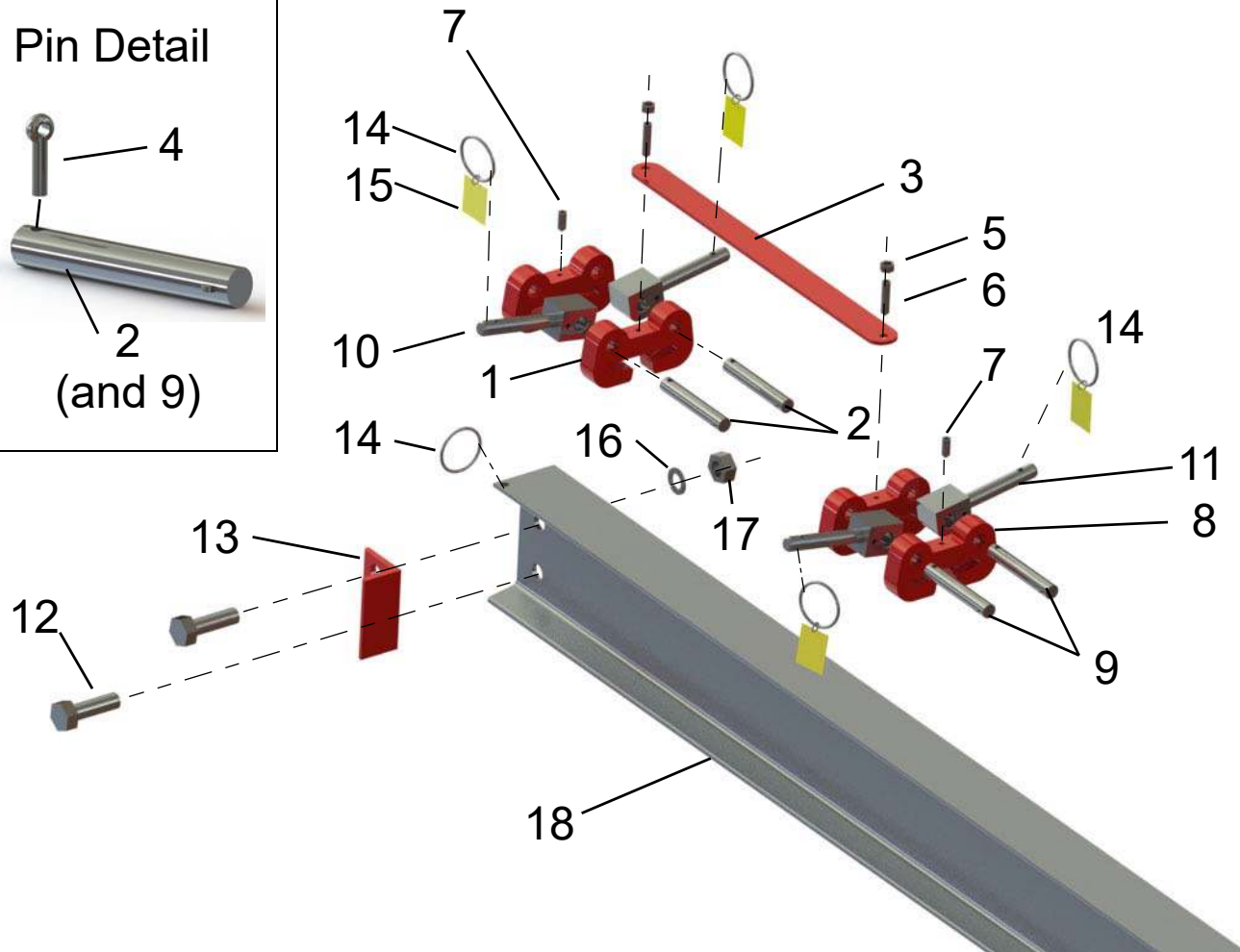
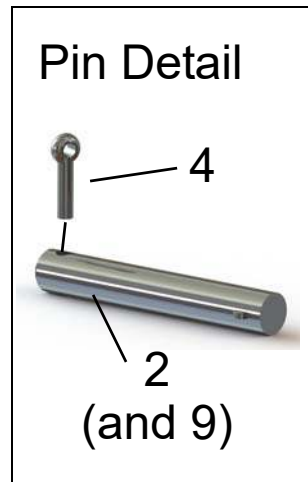

I-Beam
Assembly
Parts Location

Wallace Cranes
71 N Bacton Hill Rd.
Malvern, PA 19355



www.wallacecranes.com
800-553-5438
©2017 All rights reserved



Caster Frame
Assembly
Parts Location

Wallace Cranes
71 N Bacton Hill Rd.
Malvern, PA 19355



www.wallacecranes.com
800-553-5438
©2017 All rights reserved