

MODEL NUMBER 5T24-15AC

ITEM NO.	PART DESCRIPTION	PART NUMBER	QUAN.
1	SUPPORT PIN 1 DIA. X 6 3/16 LG.	5018-0003	4
2	MAIN LEG BRACKET	6012-1	4
3	HEX. NUT 3/8-24NF	54-0100	8
4	SOC. SET SCREW 3/8-24NF X 1 3/4 LG.	63-0110	8
5	PIN - SUPPORT 11/16 DIA. X 5 11/16 LG.	5017-0006	4
6	SPACER BAR 34 1/16 LG.	5307-3406	2
7	BRACE LEG BRACKET	6012-2	4
8	I-BEAM STL. 12" X 15' LG.	763-0150	1
9	CAUTION TAG No. 399	1969-RING	12
10	KEY RING 2 1/4 DIA.	82-0030	14
11	LOCK WASHER INT. TOOTH 3/4	58-0040	4
12	HEX. NUT 3/4-10NC	54-0040	4
13	TROLLEY STOP ANGLE	5132-0000	4
14	HEX. HD. BOLT 3/4-10NC X 2 1/2 LG.	51-0480	4
15	BRACE LEG	5014-0001	4
16	MAIN LEG ASSEMBLY	5008-0151	4
17	UPPER MAIN LEG	5034-0001	4
18	ROLL PIN 5/32 X 3/4 LG.	61-0300	4
19	LOAD PIN CASTING	3016-0000	4
20	EXTENSION SPRING	1017-0000	8
21	LOWER MAIN LEG	5035-0001	4
22	SAFETY STOP ASSEMBLY	3112-0001	4
23	CASTER FRAME ASSEMBLY	5007-0150	2
24	SAFETY CABLE ASS'Y 160" LG.	5028-0001	2
25	OUTER CASTER FRAME TUBE	5016-0001	2
26	CASTER FRAME ADJUSTMENT PIN	5139-0000	2
27	INNER CASTER FRAME TUBE	5051-0001	2
28	HEX. HD. BOLT 1/2-13NC X 3 1/2 LG.	51-0500	2
29	CASTER PLATE	5030-0000	4
30	LOWER MAIN LEG PIN 3/4 DIA. X 5 1/8 LG.	5023-0000	4
31	HEX. HD. BOLT 1/2-13NC X 4 LG.	51-0460	6
32	HEX. HD. BOLT 1/2-13NC X 1 3/4 LG.	51-0300	32
33	CASTER WHEEL 8" DIA.	47-81NB	8
34	LOCK WASHER INT. TOOTH 1/2	58-0020	40
35	HEX. NUT 1/2-13NC	54-0050	40



Wallace Cranes Parts Location

Square Tube Tri-Adjustable 2 - 5 Ton



I-Beam
Assembly
Parts Location

Wallace Cranes
71 N Bacton Hill Rd.
Malvern, PA 19355



www.wallacecranes.com
800-553-5438
©2017 All rights reserved



Caster Frame
Assembly
Parts Location

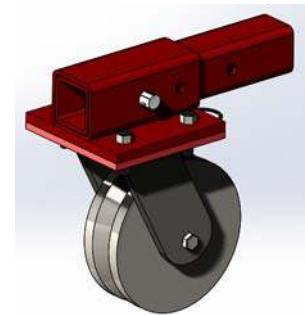

Alternate
V-Groove Caster
Part No. 5047

Wallace Cranes
71 N Bacton Hill Rd.
Malvern, PA 19355



www.wallacecranes.com
800-553-5438
©2017 All rights reserved