

MODEL NUMBER 15T24-25

ITEM NO.	PART DESCRIPTION	PART NUMBER	QUAN.
1	PIN - MAIN LEG 1 1/8 DIA. X 9 1/4 LG.	5529-0000	4
2	COTTER PIN 1/4 X 2 LG.	60-0040	20
3	HEX. NUT 3/8-24NF	54-0100	8
4	SOC. SET SCREW 3/8-24NF X 1 3/4 LG.	63-0100	8
5	SPACER BAR 32 3/8 LG.	5504-0000	2
6	PIN - BRACE LEG 7/8 DIA. X 8 3/8 LG.	5524-0000	4
7	BRACE LEG BRACKET	6224-2	4
8	KEY RING 2 1/4 DIA.	82-0030	14
9	CAUTION TAG No. 399	1969-RING	12
10	I-BEAM STL. 24" X 25' LG. REINF.	1724-0251	1
11	MAIN LEG BRACKET	6224-1	4
12	TROLLEY STOP ANGLE	5505-0000	4
13	HEX. HD. BOLT 1-8NC X 3 1/4 LG.	51-0514	4
14	LOCK WASHER 1"	57-0090	4
15	HEX. NUT 1-8NC	54-0010	4
16	LEG - UPPER MAIN	5530-0001	4
17	PIN - BRACE LEG 1 DIA. X 5 3/4 LG.	5018-0002	4
18	HEX. HD. BOLT 5/8-11NC X 6 1/2 LG.	51-0504	8
19	LEG - LOWER MAIN	5532-0111	4
20	INNER JOINT TUBE	5531-0001	4
21	LOCK WASHER INT. TOOTH 5/8	58-0030	36
22	HEX. NUT 5/8-11NC	54-0020	36
23	BRACE	5527-0024	2
24	BRACE LEG	5525-0001	4
25	CASTER FRAME TUBE	5510-0131	2
26	CASTER WHEEL V-GROOVE	47-0304	4
27	HEX. HD. BOLT 5/8-11NC X 2 LG.	51-0036	16
28	PIN - LOWER MAIN 1 1/8 DIA. X 7 1/2 LG.	5533-0000	4
29	CASTER PLATE	5544-0000	4
30	HEX. HD. BOLT 5/8-11NC X 6 LG.	51-0502	12

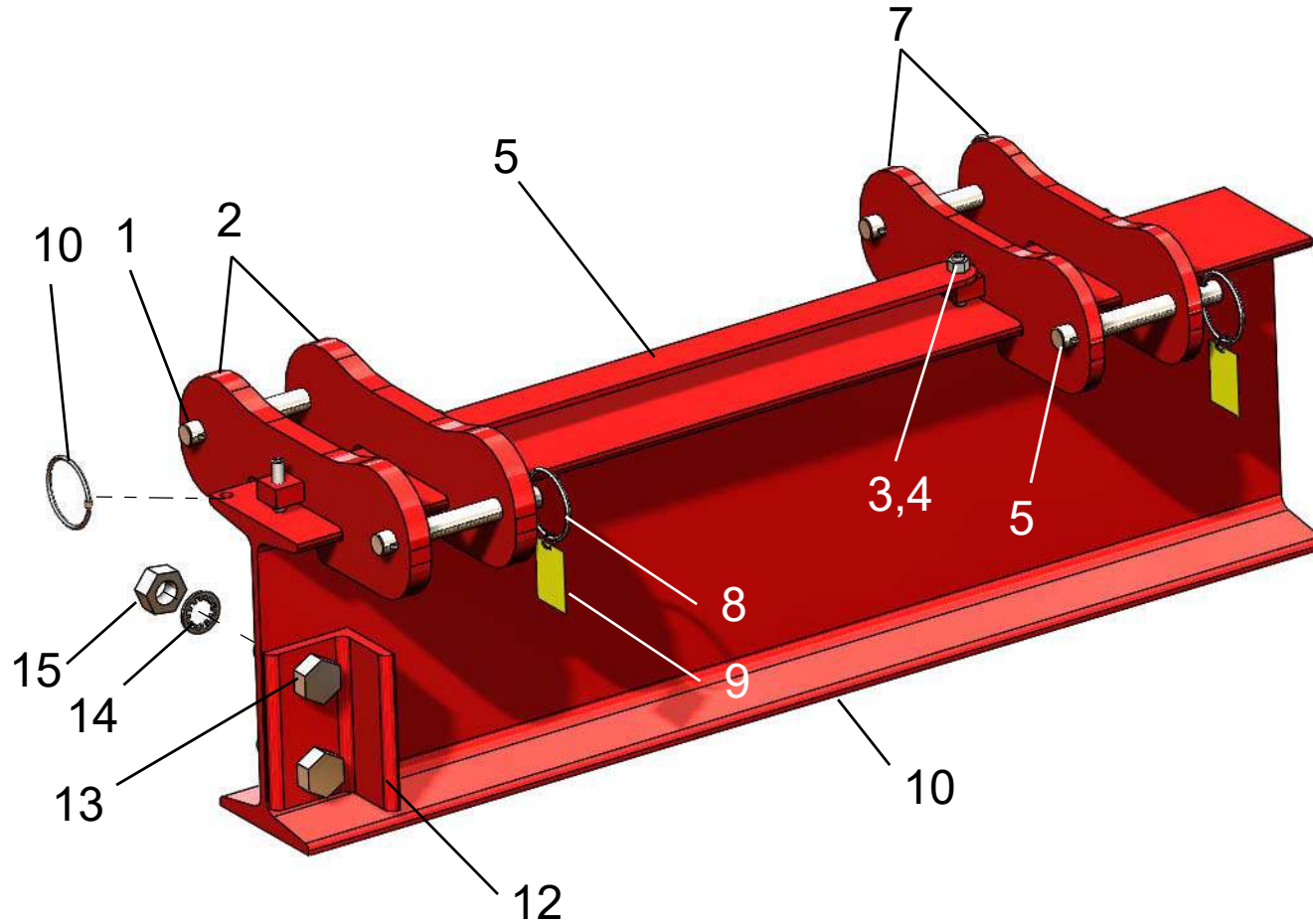

Wallace Cranes Parts Location

15 Ton Fixed Height



I-Beam
Assembly
Parts Location

Wallace Cranes
71 N Bacton Hill Rd.
Malvern, PA 19355



www.wallacecranes.com
800-553-5438
©2017 All rights reserved

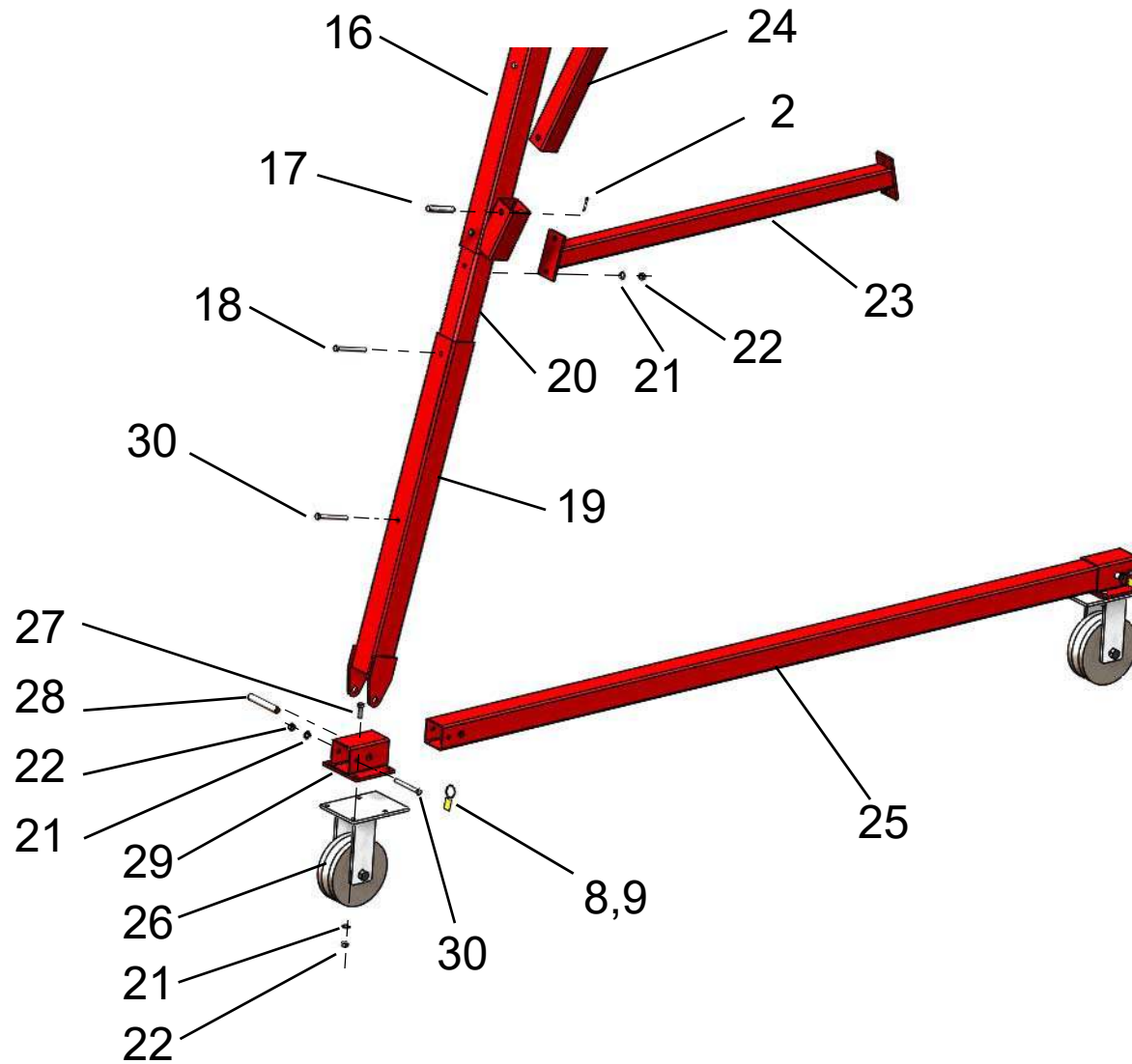

Caster Frame
Assembly
Parts Location

NOTE:
The Brace (Part 23)
is not used on all
models of this crane.

Wallace Cranes
71 N Bacton Hill Rd.
Malvern, PA 19355



www.wallacecranes.com
800-553-5438
©2017 All rights reserved